

Article number: 2310308561ESD

Description: E+G Antistatic base for levelling elements
LV.A-80-14-AS-M16x168-ESD-C

Measures

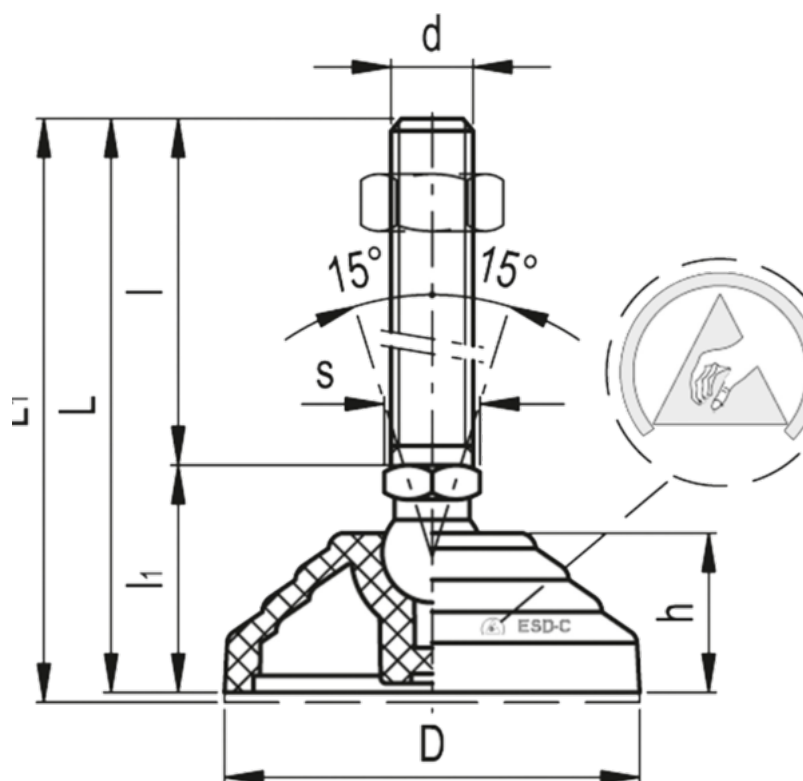

Articulation	= 14	Max load	= 16000
D	= 80	s	= 16
d	= M16	Weight in (g)	= 319
h	= 24		
l	= 168		
l1	= 33		
L	= 201		
L1	= 204		